

NOTES:

- 1. BRASS AND ZINC BODY, NICKEL PLATED
- 2. ALL DIMENSIONS ARE REFERENCE

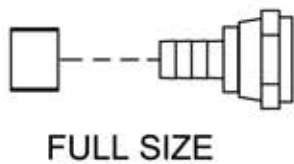
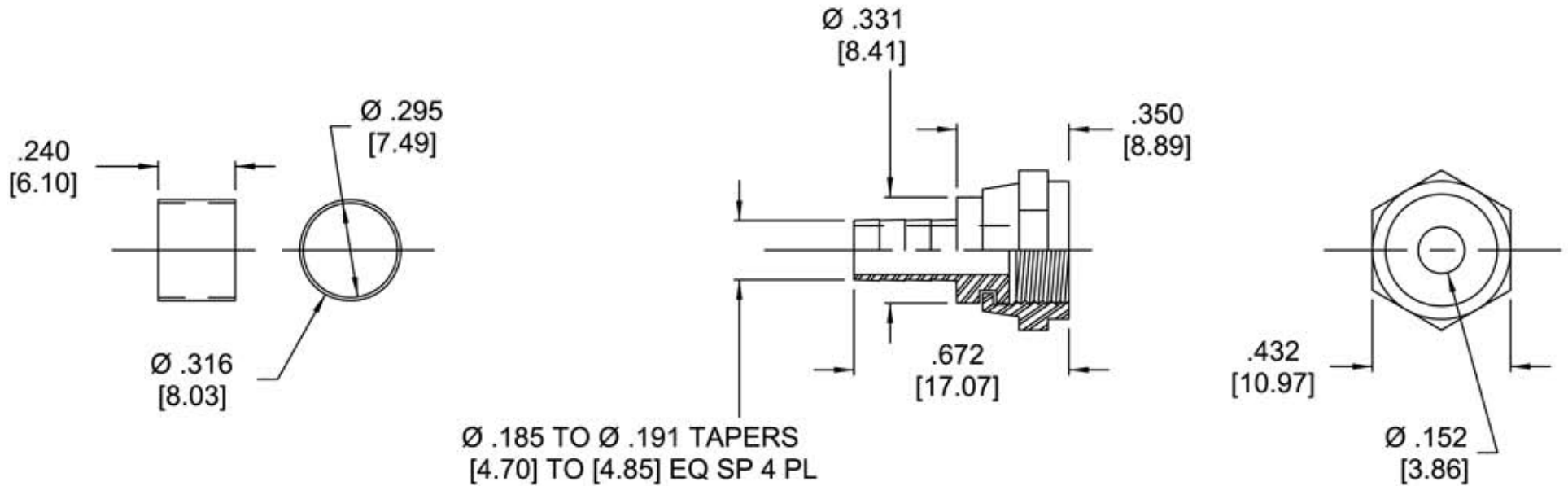

Allen Tel Products, Inc.
30 TV5 DRIVE • HENDERSON, NV • 89014

CT701
(F-59) FOR RG-59 PVC CABLE